

TRUCK

SECTION



DESCRIPTION	KAPOOR NR	O.E.M. NR.		
REAR ENGINE MOUNT	KA 2003	6328287		
FRONT ENGINE MOUNT	KA 2004	6331954		
AIR HOSE PIPE SET OF 4	KA 2005			
FRONT SPRING SHACKLE BUSH TK	KA 2034	7151023	Q 19	
REAR SPRING BUSH TK KM	KA 2035	7167443	22.5x46.7x79x76	

DESCRIPTION	KAPOOR NR	O.E.M. NR.		
PROPELLER SHAFT CUSHION	KA 2036	6314120		
CLUTCH BUSH	KA 2093		Q 16	
FRONT CABIN MOUNT	KA 2149	7131004		
SHOCK ABSORBER BUSH	KA 2219			
FRONT ENGINE MOUNT TK-TL 500	KA 2250	8839601		

DESCRIPTION	KAPOOR NR	O.E.M. NR.	
FRONT ENGINE MOUNT 3"	KA 2148	NRC 9560	
FRONT CABIN MOUNT BMC	KA 2338	4K 7731	
PROPELLER SHAFT MOUNT 7 TONNER	KA 2472	21K 7178	
REAR ENGINE MOUNT BMC	KA-2625	11K 5734	

DESCRIPTION	KAPOOR NR	O.E.M. NR.		
PROPELLER SHAFT BUSHIDAF	KA-2636	124933633	12.5x30x36x28.5	
FRONT CABIN MOUNT 2800		633981		
REAR ENGINE MOUNT 2100 (GROOVE TYPE)		247696		
FRONT ENGINE MOUNT 2800		676331		
REAR ENGINE MOUNT 2800		295669		

DESCRIPTION	KAPOOR NR	O.E.M. NR.		
PROPELLER SHAFT CUSHION KBZ	KA 2522	8-94204-521-0		
PROPELLER SHAFT CUSHION KB20	KA 2529	8-94202-521-0		
ENGINE MOUNT RIGHT KBD 250	KA 2547	8-94243-013-2		
MASTER CYLINDER BOOT	KA-2756	5-87831-081-0		
FRONT SPRING BUSH MD 27	KA-2871		16X40X42X34	

DESCRIPTION	KAPOOR NR	O.E.M. NR.		
PROPELLER SHAFT BUSH DAF	KA 2042	1283618	12.5x30x36x28.5	
FRONT CABIN MOUNT 2800	KA-2632	633981		
REAR ENGINE MOUNT 2100 (GROOVE TYPE)	KA-2633	247696		
FRONT ENGINE MOUNT 2800	KA-2634	676331		
REAR ENGINE MOUNT 2800	KA-2635	295669		

DESCRIPTION	KAPOOR NR	O.E.M. NR.	
PROPELLER SHAFT CUSHION	KA-2636	248555	





DESCRIPTION	KAPOOR NR	O.E.M. NR.	
ENGINE MOUNT O/M ZY ESHN-301	KA-2732	12031-1190	
ENGINE MOUNT N/M ZY EF750, EF2M, NS270	KA-2733	12031-1610 12031-1590	
PROPELLER SHAFT SUPPORT CSHN-151	KA-2734	37235-1161	
FRONT ENGINE MOUNT ESHN-322	KA-2950	33018-1022	
ENGINE MOUNT	KA-2951	12031-1251A	

DESCRIPTION	KAPOOR NR	O.E.M. NR.	
REAR ENGINE MOUNT ZY EF750, FS270	KA-21127	12035-2560	

DESCRIPTION	KAPOOR NR	O.E.M. NR.		
SUSPENSION BUSH LOWER KB 26	KA 2104	8-94223-366-0	14.5X36 X 63 X 54	
SUSPENSION BUSH UPPER KB 26	KA 2105	8-94226-557-2	18 X 36 X 44 X 37	
PROPELLER SHAFT CUSHION TXD 50	KA 2114	9-37516-042-0		
TORSION BAR BUSH	KA 2125	9-51631.619.0		
SPRING SHACKLE BUSH TROOPER	KA 2127			

DESCRIPTION	KAPOOR NR	O.E.M. NR.		
FRONT SPRING BUSH	KA 2128	5-51351-028-0	16 X 30 X 70 X 59	
STABILIZER BAR BUSH TROOPER	KA 2130	8-94223-157-0		
STABILIZER BAR BUSH	KA 2132	9-51779-631-1		
FRONT ENGINE MOUNT TXD 50-55	KA 2150	9-53215-088-0		
SPRING BUSH FRM, TFR	KA 2169B	8-94171-274-1	14 X 40 X 70 X 61	

DESCRIPTION	KAPOOR NR	O.E.M. NR.		
REAR SPRING BUSH ELF	KA 2235	9-51351-029-0		
FRONT SPRING BUSH ELF	KA 2239	9-51151-023-0	16 X 42 X 81 X 72	
FRONT ENGINE MOUNT CXZ	KA 2283	1-53215-132-1		
UPPER ARM BUSH TFR	KA 2354	8-94408-840-2	18 X 38 X 44 X 33	
FRONT ENGINE MOUNT NKR LHS	KA 2358A	8-94172-019-1		

DESCRIPTION	KAPOOR NR	O.E.M. NR.	
FRONT ENGINE MOUNT NKR RHS	KA 2358B	8-94172-018-1	
FRONT ENGINE MOUNT NPR LHS	KA 2358C	8-97106-759-0	
FRONT ENGINE MOUNT NPR RHS	KA 2358D	8-97092-068-0	
GEAR BOX MOUNT NKR	KA 2359	5-53325-010-0	
PROPELLER SHAFT CUSHION NKR	KA 2360	5-37516-006-1	

DESCRIPTION	KAPOOR NR	O.E.M. NR.		
FRONT SPRING BUFFER NKR	KA 2361	9-53365-603-0		
REAR SPRING BUFFER NKR	KA 2362	5-53366-007-0		
REAR SPRING BUSH NPR	KA 2364	8-94118-588-0	16 X 40 X 43 X 31	
FRONT ENGINE MOUNT WFR 1800 BUS LHS	KA 2387	8-94177-241-1		
FRONT ENGINE MOUNT WFR 1800 BUS RHS	KA 2388	8-94177-240-1		

DESCRIPTION	KAPOOR NR	O.E.M. NR.	
GEAR BOX MOUNT KB21, KB26	KA 2393	8-94229-300-2	
ENGINE MOUNT KB230, KB160, LHS	KA 2395	8-94422-867-2	
ENGINE MOUNT KB230, KB160, RHS	KA 2396	8-94422-868-2	
FRONT STABILIZER BUSH WFR	KA 2456	8-9422-050-1	
FRONT STABILIZER BUSH KBD41	KA 2473	8-94227-061-0	

DESCRIPTION	KAPOOR NR	O.E.M. NR.	
REAR SUSPENSION BUSH KB20	KA 2479	5-51151-007-0	
FRONT STABILIZER BUSH KB230	KA 2481	9-89445-945-9	
FRONT SHOCK ABSORBER BUSH KB20, KB25	KA 2482	9-51631-619-1	
REAR SUSPENSION BUSH WFR 1800 BUS	KA 2516	8-94226-805-0	
REAR SUSPENSION BUSH KB20, KBD40	KA 2521		

DESCRIPTION	KAPOOR NR	O.E.M. NR.		
SUSPENSION BUSH MD 27	KA-2871A		16X40X42X34	
GEAR BOX MOUNT MD 27	KA-2873			
STABILIZER BUSH ISUZU MD 27	KA-21001	894440790		
SILENT BLOC ISUZU MD 27	KA-21003			
SPRING BUSH	KA-21067			

DESCRIPTION	KAPOOR NR	O.E.M. NR.		
SPRING BUSH	KA-21076	8.87074826.0	18.5X42X81X70	
ENGINE MOUNT 6BG1	KA-21086	1-53225354-0		
ENGINE MOUNT 6HE1	KA-21087	1-53225-192-0		

DESCRIPTION	KAPOOR NR	O.E.M. NR.	
FRONT ENGINE MOUNT 180E37 EUROTRACKER	KA-2637	41003133EZ	
REAR ENGINE MOUNT 180E37 EUROTRACKER	KA-2638	41003136EZ	
ENGINE MOUNT BUS	KA-2639	50032016	
STABILIZER BUSHING 180E37 EUROTRACKER	KA-2640	98469634	
SUPPORT RUBBER TURBO	KA-2644	3001471	

DESCRIPTION	KAPOOR NR	O.E.M. NR.		
EXHAUST MOUNT EUROTRACKER	KA-2976			
PROPELLER SHAFT ASSEMBLY DAILY	KA-21068	42535254		
STABLIZER BUSH	KA-21075	816 2306	28X 68X50	

KA-21241

12031-E0040
Front Engine Mount Hino
ZS



KA-21242

12035-3191
Rear Engine Mount Hino
ZS



KA-21243

11328-Z2005
Rear Engine Mount
RD8



KA-21244

95142-Z4000
Rear Cabin Mount
PD6/UD4



KA-21246

11328-Z4003 / 11328-90005 / 11328-90108
Front engine mount
PD6 / UD4





KA-51001

Buffer RH



KA-51002

37235-1210
Center Bearing



KA-51003

12035-1050
Engine Mounting



KA-51004

Silent Block Bush

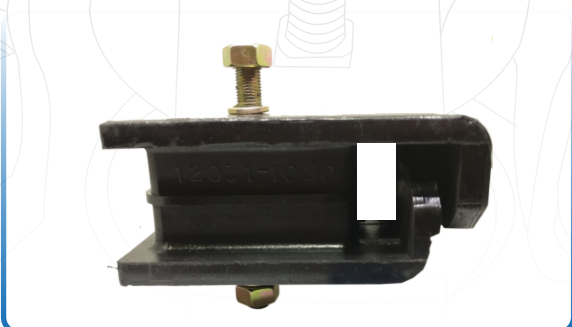

KA-51005

12031-1020
Engine Mounting

KA-21241

12031-E0040
Front Engine Mount Hino
ZS



KA-21242

12035-3191
Rear Engine Mount Hino
ZS



KA-21243

11328-Z2005
Rear Engine Mount
RD8



KA-21244

95142-Z4000
Rear Cabin Mount
PD6/UD4



KA-21246

11328-Z4003 / 11328-90005 / 11328-90108
Front engine mount
PD6 / UD4



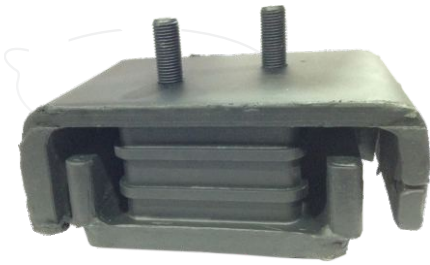

KA-21245

11328-Z4003
Front Engine Mount
PD6/UD4



KA-21181

17881-54420
Air cleaner hose Hiace
LH112



KA-21182

17881-31020 / 17881-0D050
Air cleaner hose Hiace, Altis

DESCRIPTION	KAPOOR NR	O.E.M. NR.	
STEERING COUPLING KOMATSU BIG	KA-2968		
STEERING COUPLING KOMATSU SMALL	KA-2969		
SUPPORT KOMATSU	KA-21000		

DESCRIPTION	KAPOOR NR	O.E.M. NR.		
REAR SHOCK ABSORBER BUSH 110	KA 2037	NRC 5593	Q19	
TOP LINK BUSH 110	KA 2038	NTC 1773	19 X 41 X 54 X 38	
BOTTOM LINK BUSH 110	KA 2039	566200	16 X 35 X 61 X 58	
CHASSIS ARM RUBBER BUSH 110	KA 2040	NRC 4514		
PAN HARD ROD BUSH 110	KA 2043	NRC 9728	14 X 30 X 45 X 38	

DESCRIPTION	KAPOOR NR	O.E.M. NR.		
FRONT SPRING BUSH 109	KA 2055	548205	14.5 X 30 X 70 X64	
FRONT ENGINE MOUNT SERIES II DIESEL	KA 2091	562688		
SHOCK ABSORBER BUSH	KA 2094	243057		
ENGINE MOUNT 109 2.14	KA 2102	NRC 2053		
ENGINE MOUNT FRONT 109 2.5	KA 2103	NRC 2054		

DESCRIPTION	KAPOOR NR	O.E.M. NR.		
RADIUS ARM BUSH 110	KA 2124	NTC 1774	16 X 50.7 X 46 X 38	
BOTTOM LINK TO FRAME MOUNT 110	KA 2129	NRC 7491		
ENGINE MOUNT 110 3"	KA 2148	NRC 9560		
CHASSIS BUSH 109	KA 2151	90577434	14.5 X 38 X 92 X 86	
VALVE SEAL WITH SPRING	KA 2270			



LANDROVER

179

DESCRIPTION	KAPOOR NR	O.E.M. NR.	
VALVE SEAL WITHOUT SPRING	KA 2271		

Drawings, Pictures, References from car/truck makers or OE suppliers are given for identification of the parts and have only a guidance value.

DESCRIPTION	KAPOOR NR	O.E.M. NR.	
FRONT ENGINE MOUNT CD21	KA 2002	293K 14	
REAR ENGINE MOUNT CD21	KA 2007	1632 Z9	
FRONT ENGINE MOUNT COMET -VIKING	KA 2084	581793	
FRONT ENGINE MOUNT BEAVER	KA 2085A	819450	
FRONT ENGINE MOUNT BEAVER	KA 2085B	819450	

DESCRIPTION	KAPOOR NR	O.E.M. NR.	
CABIN MOUNT LEYLAND COMET VIKING	KA 2098	275868	
RADIATOR BUSH	KA 2115		
HOSE CONNECTION RING TUSKAR	KA 2273		

DESCRIPTION	KAPOOR NR	O.E.M. NR.	
FRONT INSULATOR PAD BIG	KA-2737	10QK36B	
FRONT INSULATOR PAD MEDIUM	KA-2738	10QK370	
FRONT INSULATOR PAD SMALL	KA-2739	10QK365A	

DESCRIPTION	KAPOOR NR	O.E.M. NR.	
SUSPENSION REPAIR KIT	KA-21052	81.96210.0437	
SPRING CUSHION LEFT TGA	KA-21069	81.96210.0555	
SPRING CUSHION RIGHT TGA	KA-21070	81.96210.0554	
PROPELLER SHAFT ASSEMBLY TGA	KA-21072	81.39410.6031	
STABILIZER MOUNT	KA-21074	81.43722.0039	<div style="display: flex; align-items: center;"> <div style="writing-mode: vertical-rl; transform: rotate(180deg); font-size: small; margin-right: 10px;">22X68X62</div>  </div>

KA-21184

81.96210.0101
Rubber Buffer

40 x 50



KA-21197

81.96210.0119
Rubber Mount

50 x 50



KA-21198

81.96210.0132
Rubber Mount

50 x 40



KA-21199

81.96210.0063
Rubber Metal Buffer

34 x 43 x 16



KA-25001

81.96210.0242
Engine Mount





KA-25002

81.96210.0522
Rubber Layer Spring



KA-21073

81.43722.0063
Stabilizer mounting

68 x 22 x 45 x 62



KA-21052

81.96210.0407
Repair kit for
cabin suspension



KA-21052A

81.41700.6095
Repair kit for
cabin suspension



KA-21052B

81.96210.0437
Rubber bearing

KA-21052C

81.96210.0407
Rubber bearing



KA-21294

85.96210.0021
Bearing bush

53 x 16 x 40 x 58



KA-21294 A

81.41715.6014
Repair Kit for Cabin



KA-21295

85.96210.0019
Cabin bush

16.5 x 60 x 64 x 80



KA-21295 A

81.41715.6013
Full Repair Kit for Cabin





KA-21288

81.96210.0462
Rubber bearing

14 x 30 x 48



KA-21197

81.96210.0100
Rubber buffer

50 x 45



KA-21296

81.96210.0603
Cabin Mount Bush



KA-21290

81.96210.0339
Engine Mount



KA-21292

81.96210.0400
Cabin Mount Bush

ID=16mm; Length=30mm

KA-21292 A

81.96210.0400 S
Repair Kit for Cabin



KA-21295 C

85.41715.0006
Cabin Bushing



KA-21286

81.66440.0192
Tightening Strap
TGA



KA-21291

81.48227.0006
Pedal rubber
TGA



KA-21285

81.43704.0078
Stabilizer Bush
TGA





KA-21204

81.43704.0061
Stabilizer mounting

59 x 78 x 60



KA-25003

81.96210.0184
Gearbox mount

65 x 140 x 45



KA-25004

81.39410.6019
Propeller shaft bearing

65 mm



KA-25005

81.43722.0091
Leaf spring bush

95 x 62 x 24.5



KA-21310 A

81.43722.0070
Spring suspension bush

24 x 65 x 95

KA-21308

81.43722.0040
Stabilizer mounting

55.5 x 84 x 70



KA-25008

81.96210.0388
Gearbox mount

100 x 67



KA-21194

81.43270.6079 / 81.43270.6099
Repair kit for V- link
OD: Ø95mm; Hole: 23mm;
Length: 193mm; PCD: 152mm



KA-25010

81.95302.0077
Repair kit for V- link
OD: Ø85mm; Hole: 20mm;
Length: 170mm; PCD: 130mm



KA-25011

85.43220.6002
Repair kit for link
OD: Ø75mm; Hole: 19mm;
Length: 163mm; PCD: 130mm



KA-21366

81.43704.0060
Cabin Bush



KA-21372

81.73704.0074
Stabilizer Bush

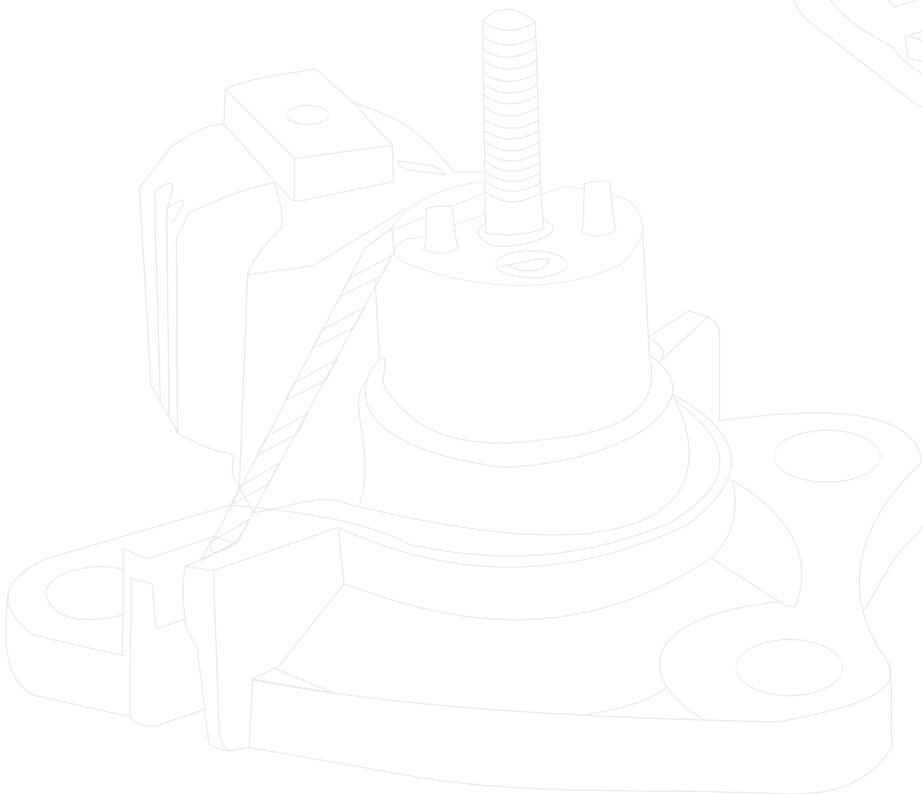
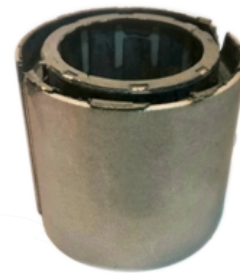





DESCRIPTION	KAPOOR NR	O.E.M. NR.	
EXHAUST MOUNT 911B	KA 2032	360 504 0012	
REAR ENGINE MOUNT 1924	KA 2033	645 240 0118	
PROPELLER SHAFT CUSHION 1621	KA 2054	363 413 0012	
EXHAUST MOUNT 1621-1924	KA 2090	336 504 0012	
FRONT ENGINE MOUNT 911B	KA 2122	352 240 0417	

DESCRIPTION	KAPOOR NR	O.E.M. NR.	
REAR ENGINE MOUNT 911B	KA 2123	352 240 0318	
ENGINE SUPPORT	KA 2134		
REAR ENGINE MOUNT 1621	KA 2154	000 242 1213	
FRONT ENGINE MOUNT 1621 -1924	KA 2155	000 241 0513	
TRANSMISSION BOOT L1924-1928	KA 2181	014 016 7800	

DESCRIPTION	KAPOOR NR	O.E.M. NR.	
CABIN MOUNT 1621	KA 2211	318 586 0031	
RADIATOR BUSH 1924-2624	KA 2226	327 504 5082	
AIR SOCKET COUPLING RUBBER 1621-1924	KA 2227	000 429 2184	
PROPELLER SHAFT CUSHION 911B	KA 2231	312 413 1112	
FRONT ENGINE MOUNT 508 PICK UP	KA 2407	310 241 03 13	

DESCRIPTION	KAPOOR NR	O.E.M. NR.	
CABIN MOUNT RUBBER 911B	KA 2408		
GEAR BOX MOUNT 1621	KA 2409	361 226 01 84	
SPRING BUFFER 1621	KA 2410	335 890 00 01	
AXLE SHAFT (GEAR BOX) BOOT UNIMOG	KA 2530	416 987 5243	
BALL JOINT BOOT KIT UNIMOG	KA 2531		

DESCRIPTION	KAPOOR NR	O.E.M. NR.		
REAR SPRING BUSH 307	KA 2535	602 324 0050	Q 12	
FRONT STABILIZER BUSH 307	KA 2536	602 321 0350	Q 12	
FRONT STABILIZER BUSH 307	KA 2536A	602 321 0250	Q 16	
FRONT STABILIZER RUBBER 307	KA 2537	602 326 0282		
FRONT SPRING BUSH 307	KA 2538	000 321 0050	Q 12	

DESCRIPTION	KAPOOR NR	O.E.M. NR.	
FRONT ENGINE MOUNT 307	KA 2539	601 242 0013	
ENGINE MOUNT (FLEX DISC) 307	KA-2576	617 180 0016	
ENGINE MOUNT 307	KA-2577	601 240 0617	
PROPELLER SHAFT KIT 307	KA-2578	601 410 04 10	
FRONT SUSPENSION KIT 307	KA-2579	126 460 0819	

DESCRIPTION	KAPOOR NR	O.E.M. NR.		
PROPELLER SHAFT SUPPORT (CPL) 307	KA-2682	601 410 1710		
AIR CLEANER SLEEVE 2626	KA-2722	320 357 0122		
SPRING BUFFER 2624	KA-2723	326 331 0044		
COMPLETE PROPELLER SHAFT SUPPORT 60 MM	KA-2724	389 410 01 22	Q60	
COMPLETE PROPELLER SHAFT SUPPORT 70 MM	KA-2724A	395 410 00 22 385 410 07 22	Q70	

DESCRIPTION	KAPOOR NR	O.E.M. NR.	
RUBBER BUFFER	KA-2809		
RUBBER BUFFER	KA-2810		
RUBBER BUFFER	KA-2870		
RUBBER BUFFER	KA-2901		
WEATHER STRIP	KA-2902		

DESCRIPTION	KAPoor NR	O.E.M. NR.	
DRIVE SHAFT BOOT	KA-2903		
ENGINE MOUNT	KA-2904		
SPRING CUSHION ACTROS	KA-21071	000 325 0596	
STABILIZER BUSH	KA-21073	000 323 8185	40X80X46 
ENGINE MOUNT ACTROS	KA-21079	941 241 59 13	

DESCRIPTION	KAPoor NR	O.E.M. NR.	
SPRING CUSHION ACTROS	KA-21095	000 325 08 96	
TRANSMISSION MOUNT LP, MK-SK	KA-21096	645 240 03 18	
ENGINE MOUNT MK-SK	KA-21097	658 241 00 13	
PROPELLER SHAFT SUPPORT ACTROS (70 MM)	KA-21100	9734100112 6564110012	Q70 
PROPELLER SHAFT SUPPORT ACTROS (60 MM)	KA-21100A	9734100112 6564110012	Q60 

DESCRIPTION	KAPOOR NR	O.E.M. NR.		
FAN HUB	KA-21102	403 200 09 26	Q 80	
FRONT ENGINE MOUNT MK-SK	KA-21103	620 240 07 17		
ENGINE MOUNT MK-SK	KA-21104	617 240 02 17		
TRANSMISSION MOUNT LK / LN2, MK-SK	KA-21105	652 240 03 18		
REPAIR KIT FOR CABIN SUSPENSION	KA-21106	620 586 00 31		

DESCRIPTION	KAPOOR NR	O.E.M. NR.		
REPAIR KIT FOR CABIN SUSPENSION	KA-21107	387 310 00 77		
STABILIZER MOUNT KIT FOR CABIN SUSPENSION	KA-21108	387 586 05 31		
FRONT SUSPENSION BUSH (OD 60)	KA-21109	000 322 03 85	Q 22	
PROPELLER SHAFT SUPPORT (55 MM)	KA-21110	385 410 09 22	Q 55	
CABIN MOUNT ACTROS	KA-21112	942 317 21 12		

DESCRIPTION	KAPOOR NR	O.E.M. NR.		
SHOCK ABSORBER BUSH ACTROS AXOR, ATEGA	KA-21113	000 320 06 44	Q 16	

KA-21106

6205860031
Repair Kit for
Cabin Suspension



KA-21107

3873100077
Repair Kit for
Cabin Suspension



KA-21108

3875860531
6203100177
Stabilizer Mount Kit for
Cabin Suspension



KA-21336

620 320 0128
Repair Kit for Stabilizer



KA-21337

620 320 0628
Repair Kit for Stabilizer





KA-21110

973 410 0022
381 410 1522
Center Bearing Ø 45mm



KA-21110A

973 410 0022
Center Bearing Ø 55mm



KA-21112

9423172112
Cabin Mount



KA-21183

6205280782
AC BOOT



KA-21190

6152400317
Front Engine Mount

KA-5069

3365040012
RADIATOR MOUNTING

75 x 65 x 35



KA-5070

3475040012
RADIATOR MOUNTING

44 x 55 x 36



KA-21111

0003223285
FRONT SPRING BUSH
Ø24.5mm x 62mm x 96mm



KA-21109

0003220385
Front Suspension Bush
Ø22mm x 60mm x 76mm



KA-21194A

000 350 0413 / 0 9319 2619 /
81.43270.6045
Axle Rod Repair Kit
OD:Ø95mm; Hole: 21mm; Length:152mm





KA-21328

942 326 0050
Axle Rod Repair Kit
OD: Ø88mm; Hole: 20mm;
Length: 172mm; PCD: 130mm.



KA-21301

460 352 5014
Stabilizer Bush
G500/AMG



KA-21334 A

000 350 3705
Axle Rod Repair Kit
OD: Ø85mm; Hole: 23mm;
Length: 166mm; PCD: 130mm.



KA-21334

000 350 2705
Axle Rod Repair Kit
OD: Ø85mm; Hole: 21mm;
Length: 195mm; PCD: 152mm.



KA-21334 B

000 350 2305
Axle Rod Repair Kit
OD: Ø85mm; Hole: 25mm;
Length: 195mm; PCD: 152mm.

KA-21216

000 350 0113
Repair kit for V- link
OD: Ø108mm; Hole: 21mm;
Length: 192mm; PCD: 152mm



KA-21323

000 323 7985
Front Torsion Bar Bush



KA-21202

941 326 0050
Stabilizer Mounting

80 x 108.5 x 67



KA-21203

941 323 0150
Stabilizer Bush

70 x 98



KA-21279

653 326 0481
Stabilizer Bush

16 x 66 x 60





KA-21206

000 326 2481
000 323 5985
Stabilizer Rubber
38 x 52 x 55



KA-21208

381 410 01522
381 410 0222
381 410 1222
Center Bearing Ø45



KA-21208 A

385 410 1722
385 410 0922
385 410 0122
Center Bearing Ø55



KA-21315

3142230112
Engine Mount OM309



KA-21317

F1757
Break Booster OM309

KA-21312

Air Filter Gasket
OM314

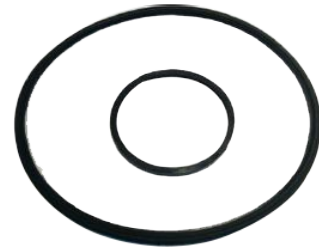

KA-21313

Air Filter Gasket
OM355



KA-21314

Air Filter Gasket
OM309



KA-21249

310 410 0922
Propeller Shaft Support



KA-21250

Gearbox Boot





KA-21316

K220180
Rubber Boot
OM314



KA-21318

338 413 0012
Propeller Shaft Cushion
OM352



KA-21336

942 317 2312
Rear Bush for Cabin Suspension



KA-21337

000 992 1603
Rear Bush for Cabin Suspension



KA-21338

000 326 2381
Anti Roll Bar Bush Rear

32.5 x 60

KA-21339

942 317 2012
Cabin Mount



KA-21340

000 326 4481
Stabilizer Bush Rear

56 x 77



KA-21341

000 326 2681
Stabilizer Bush

47 x 66



KA-21342

930 504 0114
Radiator Mount



KA-21343

942 317 1812
Cabin Suspension Bush





KA-21344

942 500 0050
Cabin Suspension Bush



KA-21345

9423172212
Rear Bush set for Cabin Suspension



KA-21346

942 504 0214
Radiator Mount



KA-21106 A

381 317 1712
Cabin Suspension Bush



KA-21106 B

381 314 1412
Cabin Suspension Ring

KA-21196A

000 350 0506

Repair kit for link

OD: Ø85mm; Hole: 19mm;
Length: 164mm; PCD: 130mm

Also suitable for :

81.43220.6107	MAN
0698 749	DAF
0 4248 8722	IVECO
50 01 842 823	RENAULT
0 638 862	SCANIA



KA-21191

000 330 0707

Repair kit for V- link

OD: Ø75mm; Hole: 17mm;
Length: 150mm; PCD: 115mm

Also suitable for :

271187	VOLVO
0698 748	DAF
0 639 370	SCANIA
81.43230.6051	MAN



KA-21192

000 350 0613

Repair kit for V- link

OD: Ø85mm; Hole: 21mm;
Length: 195mm; PCD: 152mm

Also suitable for :

274068	VOLVO
0691703	DAF
0 9319 2618	IVECO





KA-21191A

629 330 00 07

Repair kit for V- link

OD: Ø75mm; Hole: 19mm;
Length: 148mm; PCD: 115mm.

Also suitable for :

81.43270.6091

MAN

629 330 00 07

EVOBUS



KA-21192A

000 350 0113

Repair kit for V- link

OD: Ø85mm; Hole: 19mm;
Length: 170mm; PCD: 130mm

Also suitable for :

81.43220.6250

MAN

000 350 0113

EVOBUS



KA-21349

000 326 2381

Anti Roll Bar Bush



KA-21353

645 528 0182

Rubber Molded Hose

KA-21365

404 200 0226
Fan Hub Tall



KA-3031

404 200 0226
Fan Hub Kit



KA-3031A

404 200 0226
Aluminum Support for Fan Hub



DESCRIPTION	KAPOOR NR	O.E.M. NR.		
SUSPENSION BUSH	KA 2016	MB 633820	Q 18.5	
STABILIZER BUSH PAJERO	KA 2139	MB 338595		
DRIVE SHAFT BOOT OUTER PAJERO	KA 2140	MB 160657		
DRIVE SHAFT BOOT INNER PAJERO	KA 2141	MB 160658		
SPRING BUSH L 300	KA 2142	MB 111070		





DESCRIPTION	KAPOOR NR	O.E.M. NR.		
SPRING BUSH L 300	KA 2143	MB 111203		
SPRING BUSH L 300	KA 2144	MB 111071		
SUSPENSION BUSH L 300	KA 2212	MB 584166	Q 16	
SILENT BLOCK BUSH	KA 2213	MB 631492	16 X 65 X 60 X 40	
FRONT ENGINE MOUNT	KA 2214	MB 007023		

DESCRIPTION	KAPOOR NR	O.E.M. NR.	
PROPELLER SHAFT SUPPORT	KA 2215	MB 581845	
PROPELLER SHAFT SUPPORT	KA 2216	MB 260676	
SPRING BUFFER	KA 2217	MB 242119	
STABILIZER BUSH	KA 2218	MB 573783	
FRONT SPRING BUSH CANTER	KA 2233	MB 025153	

DESCRIPTION	KAPOOR NR	O.E.M. NR.	
LOWER ARM BUSH L 200	KA 2238	MB 109529	
TORSION BAR BUSH L 200	KA 2247	MB 809388	
SPRING BUFFER CANTER L+R SET OF 2	KA 2272	MB 025453/4	
PROPELLER SHAFT CUSHION CANTER	KA 2297	MB 000076	
CONTROL ARM BUSH FUSO	KA 2300	MC 812666	

DESCRIPTION	KAPOOR NR	O.E.M. NR.	
FRONT ENGINE MOUNT CANTER	KA 2318	ME 011832	
REAR SPRING BUFFER CANTER	KA 2363	MT-104718	
GEAR BOX MOUNT CANTER	KA 2411	MB-201952	
FRONT ENGINE MOUNT FUSO TRUCK	KA 2421	ME 031962	
PROPELLER SHAFT CUSHION FUSO TRUCK	KA 2422	12091-25403	



DESCRIPTION	KAPOOR NR	O.E.M. NR.	
FRONT STABILIZER BUSH L300	KA 2505	MB 175581	
AIR CLEANER HOSE WITH SPRING CANTER	KA 2559	MB 390261	
STABILIZER BUSH L300	KA 2575	MB 175534	
STABILIZER BUSH	KA-2631	MB 175804	
GEAR BOX MOUNT 6D16 FUSO	KA-21082	ME 031964	

DESCRIPTION	KAPOOR NR	O.E.M. NR.	
GEAR BOX MOUNT 6D16 FUSO	KA-21083	ME 071774	
FRONT ENGINE MOUNT 6D22 / 6D40 FUSO	KA-21084	MK 373100	
REAR ENGINE MOUNT 6D22 / 6D40 FUSO	KA-21085	MK 412047	
DRIVE SHAFT BOOT PAJERO	KA-21092		

DESCRIPTION	KAPOOR NR	O.E.M. NR.		
GEAR BOX MOUNT BIG	KA-2710		22X74X110X49	
GEAR BOX MOUNT MEDIUM	KA-2711		22.5X74X90X42	
GEAR BOX MOUNT SMALL	KA-2712		21X65X76X30	
FRONT CABIN BUSH 310	KA-2713		28X48X55X50	
REAR STABILIZER BUSH	KA-2714		Q 32	

DESCRIPTION	KAPOOR NR	O.E.M. NR.	
ENGINE MOUNT 310 / 340 TRUCK	KA-2718		
CABIN MOUNT 310	KA-2764		
CABIN MOUNT GLR 190	KA-2766		
ENGINE MOUNT GK 60 310	KA-2768		
CABIN MOUNT GLR-190	KA-2779		

DESCRIPTION	KAPOOR NR	O.E.M. NR.	
GEAR LEVER COVER 310	KA-2787		
REAR ENGINE MOUNT GLR 190	KA-2788		
SILENT BLOC 310 G/M	KA-2791		
ENGINE MOUNT GBH	KA-2793		
BONNET HOOD RUBBER	KA-2796	50 00 788 113	

DESCRIPTION	KAPOOR NR	O.E.M. NR.	
RADIATOR MOUNT TRUCK GLR 190	KA-2815		
STEERING COUPLING TRUCK JU 13	KA-2816	50001 34747	
WATER PUMP MOUNT GLR 190	KA-2821		
WATER PUMP MOUNT 310	KA-2822		
CHASSIS MOUNT RENAULT 310 PM	KA-2824	50007 88113	

DESCRIPTION	KAPOOR NR	O.E.M. NR.		
CHASSIS MOUNT RENAULT 310 GM	KA-2825	50103 83951		
CABIN MOUNT BUSH 310 SMALL	KA-2833		12X24X38X35	
CABIN MOUNT BUSH 310 BIG	KA-2834		11X40X42X21	
TAIL LAMP MOUNT	KA-2835			
REAR CABIN MOUNT 310	KA-2851			



DESCRIPTION	KAPOOR NR	O.E.M. NR.	
AIR CLEANER RUBBER 310	KA-2857		
AIR CLEANER HOSE TURBO 310	KA-2863		
GEAR BOX MOUNT JU 13	KA-2869		
GEAR ROD RUBBER COVER GBH	KA-2872		
GEAR BOX MOUNT GK 60 G/D	KA-2876		

DESCRIPTION	KAPOOR NR	O.E.M. NR.		
SILENT BLOCK BUSH 310	KA-2911	50101 30430	18X48X69X50	
AIR CLEANER HOSE TB 340	KA-2943			
ENGINE MOUNT GBH	KA-2944			
SPRING BUFFER 340	KA-2980			
REAR ENGINE MOUNT KIRAKASS	KA-2981			

DESCRIPTION	KAPOOR NR	O.E.M. NR.	
RADIATOR MOUNT 310	KA-21077		
STABILIZER BUSH	KA-21093		

DESCRIPTION	KAPOOR NR	O.E.M. NR.		
ENGINE MOUNT SG4	KA 2423			
SILENT BLOCK BUSH SG4	KA 2424	S000000922	18 X 34 X 54 X 50	
SILENT BLOCK BUSH SG4	KA 2425	S000000921	26 X 44 X 66 X 50	
GEAR BOX MOUNT SG4	KA-2767	0.8454283400		
CABIN MOUNT SG4	KA-2777	0.855681000		

DESCRIPTION	KAPOOR NR	O.E.M. NR.	
REAR SPRING BUSH SG4	KA-2778		
SHOCK ABSORBER MOUNT SG4	KA-2786		
STEERING COUPLING	KA-2812		
PROPELLER SHAFT CUSHION SG4	KA-2817		
GEAR BOX MOUNT SG4 G/M	KA-2820		

DESCRIPTION	KAPOOR NR	O.E.M. NR.	
SPRING BUFFER SG4 G/M	KA-2823		
RUBBER PAD FANTRA SG2	KA-2862		

DESCRIPTION	KAPOOR NR	O.E.M. NR.	
ENGINE MOUNT	KA-21101	0137207	



KA-21295A

8596210019
Cabin Suspension Bush



KA-21371

Aluminum Mounting

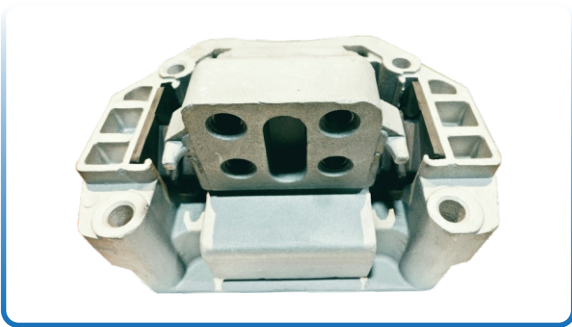

KA-21373

1921972
Engine Mount

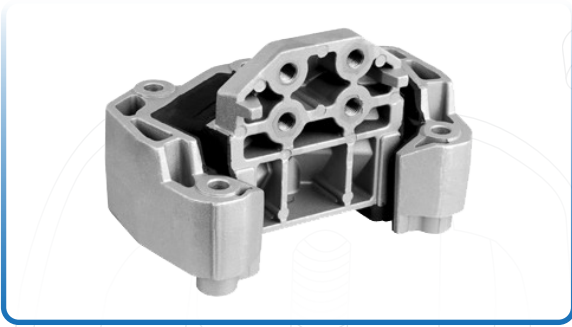

KA-21374

1336882
Transmission Mounting



KA-21375

364833
Transmission Mounting

KA-21371A

2 HOLE ALUMINIUM MOUNT



KA-21403

294271
CENTER BEARING 60MM



KA-21405

146526
RUBBER BEARING SMALL



KA-21406

RUBBER BEARING BIG



KA-21407

1356668
CABIN SUSPENSION BUSH





KA-21408

1362710
SPRING BUSH



DESCRIPTION	KAPOOR NR	O.E.M. NR.	
REAR ENGINE MOUNT K 120	KA-2625A	094.5331007	
GEAR LEVER COVER K120 / K66	KA-2703	0005010902	
CLUTCH & BRAKE PEDAL RUBBER K 66 / K 120	KA-2704	0.501032	
SILICON WASHER ROUND	KA-2708		
CABIN MOUNT K 66	KA-2709	000.5003099	

DESCRIPTION	KAPOOR NR	O.E.M. NR.	
STEERING ROD BUSH K 66 / K 120	KA-2755	000.0489233	
ENGINE MOUNT BERLIET GLM 12	KA-2765		
CABIN MOUNT TB-305	KA-2770		
FRONT SPRING BUFFER K66	KA-2774	000.5010966	
REAR SPRING BUFFER K66	KA-2775	000.5003111	

DESCRIPTION	KAPOOR NR	O.E.M. NR.	
REAR ENGINE MOUNT K66	KA-2781		
CHASSIS MOUNT B 260	KA-2789		
COMPLETE CUSHION 49 V8	KA-2794		
PROPELLER SHAFT CUSHION K 120	KA-2818		
ENGINE MOUNT B 260	KA-2839	000.1118399	

DESCRIPTION	KAPOOR NR	O.E.M. NR.	
CABIN MOUNT K 66	KA-2852	00 00 703 308	
FRONT CABIN MOUNT GAK	KA-2853		
STABILIZER BUSH K 120 BIG MODEL	KA-2854		
RUBBER BUSH 25 L 4	KA-2855		
RADIATOR MOUNT	KA-2856	00 23 535 333	



DESCRIPTION	KAPOOR NR	O.E.M. NR.	
STABILIZER BUSH 100 V8 BIG MODEL	KA-2859		
STABILIZER BUSH 100 V8 SMALL MODEL	KA-2860		
STABILIZER BUSH TITANE	KA-2861		
GEAR ROD RUBBER BOOT 25 L 4	KA-2864		
CABIN MOUNT TB 340	KA-2874		

DESCRIPTION	KAPOOR NR	O.E.M. NR.	
STEERING RUBBER PAD K 66	KA-2875	000.5010217	
FRONT ENGINE MOUNT K 66 / K 120	KA-2879	0005003098	
COMPLETE PROPELLER SHAFT ASSEMBLY 55	KA-2905		
COMPLETE PROPELLER SHAFT ASSEMBLY 50	KA-2906		
COMPLETE PROPELLER SHAFT ASSEMBLY 45	KA-2907		

DESCRIPTION	KAPOOR NR	O.E.M. NR.	
<p>COMPLETE PROPELLER SHAFT ASSEMBLY 40</p>	<p>KA-2908</p>		
<p>COMPLETE PROPELLER SHAFT ASSEMBLY 35</p>	<p>KA-2909</p>		
<p>CABIN MOUNT C 260</p>	<p>KA-2947</p>		
<p>ENGINE MOUNT 913</p>	<p>KA-2949</p>		
<p>ENGINE MOUNT</p>	<p>KA-2953</p>		

DESCRIPTION	KAPOOR NR	O.E.M. NR.		
COMPLETE PROP SHAFT ASSEMBLY 60MM	KA-2954			
ENGINE MOUNT	KA-2955			
FRONT SPRING MOUNT K 120	KA-2978			
SILENT BLOC BUSH BERLIET	KA-2983		24X58X60X50	
SILENT BLOC BUSH BERLIET	KA-2984		16X52X48X39	

DESCRIPTION	KAPOOR NR	O.E.M. NR.		
SILENT BLOC BUSH BERLIET	KA-2985		20X44X45X37	
SILENT BLOC BUSH BERLIET	KA-2986		21.5X40X40.5X37	
BONNET RUBBER SONACOM K 66	KA-2999			
ENGINE MOUNT GAK 30	KA-21005			
RUBBER BUSH	KA-21007			

DESCRIPTION	KAPOOR NR	O.E.M. NR.	
INJECTOR PUMP COUPLING (BERLIET)	KA-21008		
CABIN RUBBER PAD GAK 30	KA-21010		
CONTROL ARM BUSH C 260	KA-21051		

DESCRIPTION	KAPOOR NR	O.E.M. NR.	
REAR ENGINE MOUNT K 120	KA-2625A	094.5331007	
GEAR LEVER COVER K120 / K66	KA-2703	0005010902	
CLUTCH & BRAKE PEDAL RUBBER K 66 / K 120	KA-2704	0.501032	
SILICON WASHER ROUND	KA-2708		
CABIN MOUNT K 66	KA-2709	000.5003099	

DESCRIPTION	KAPOOR NR	O.E.M. NR.	
STEERING ROD BUSH K 66 / K 120	KA-2755	000.0489233	
ENGINE MOUNT BERLIET GLM 12	KA-2765		
CABIN MOUNT TB-305	KA-2770		
FRONT SPRING BUFFER K66	KA-2774	000.5010966	
REAR SPRING BUFFER K66	KA-2775	000.5003111	

DESCRIPTION	KAPOOR NR	O.E.M. NR.	
REAR ENGINE MOUNT K66	KA-2781		
CHASSIS MOUNT B 260	KA-2789		
COMPLETE CUSHION 49 V8	KA-2794		
PROPELLER SHAFT CUSHION K 120	KA-2818		
ENGINE MOUNT B 260	KA-2839	000.1118399	

DESCRIPTION	KAPOOR NR	O.E.M. NR.	
CABIN MOUNT K 66	KA-2852	00 00 703 308	
FRONT CABIN MOUNT GAK	KA-2853		
STABILIZER BUSH K 120 BIG MODEL	KA-2854		
RUBBER BUSH 25 L 4	KA-2855		
RADIATOR MOUNT	KA-2856	00 23 535 333	



DESCRIPTION	KAPOOR NR	O.E.M. NR.	
STABILIZER BUSH 100 V8 BIG MODEL	KA-2859		
STABILIZER BUSH 100 V8 SMALL MODEL	KA-2860		
STABILIZER BUSH TITANE	KA-2861		
GEAR ROD RUBBER BOOT 25 L 4	KA-2864		
CABIN MOUNT TB 340	KA-2874		

DESCRIPTION	KAPOOR NR	O.E.M. NR.	
STEERING RUBBER PAD K 66	KA-2875	000.5010217	
FRONT ENGINE MOUNT K 66 / K 120	KA-2879	0005003098	
COMPLETE PROPELLER SHAFT ASSEMBLY 55	KA-2905		
COMPLETE PROPELLER SHAFT ASSEMBLY 50	KA-2906		
COMPLETE PROPELLER SHAFT ASSEMBLY 45	KA-2907		

DESCRIPTION	KAPOOR NR	O.E.M. NR.	
COMPLETE PROPELLER SHAFT ASSEMBLY 40	KA-2908		
COMPLETE PROPELLER SHAFT ASSEMBLY 35	KA-2909		
CABIN MOUNT C 260	KA-2947		
ENGINE MOUNT 913	KA-2949		
ENGINE MOUNT	KA-2953		



DESCRIPTION	KAPOOR NR	O.E.M. NR.		
COMPLETE PROP SHAFT ASSEMBLY 60MM	KA-2954			
ENGINE MOUNT	KA-2955			
FRONT SPRING MOUNT K 120	KA-2978			
SILENT BLOC BUSH BERLIET	KA-2983		24X58X60X50	
SILENT BLOC BUSH BERLIET	KA-2984		16X52X48X39	

DESCRIPTION	KAPOOR NR	O.E.M. NR.		
SILENT BLOC BUSH BERLIET	KA-2985		20X44X45X37	
SILENT BLOC BUSH BERLIET	KA-2986		21.5X40X40.5X37	
BONNET RUBBER SONACOM K 66	KA-2999			
ENGINE MOUNT GAK 30	KA-21005			
RUBBER BUSH	KA-21007			

DESCRIPTION	KAPOOR NR	O.E.M. NR.	
INJECTOR PUMP COUPLING (BERLIET)	KA-21008		
CABIN RUBBER PAD GAK 30	KA-21010		
CONTROL ARM BUSH C 260	KA-21051		

DESCRIPTION	KAPOOR NR	O.E.M. NR.	
BONNET RUBBER 1210 SE	KA 2006	350552074202	
RADIATOR MOUNT 1210SE	KA 2030	042 500 00 13	
REAR SHOCK ABSORBER BUSH	KA 2031		
CABIN MOUNT RUBBER 1210 SE	KA 2072	257689107701	
CABIN MOUNT RUBBER 1210 SE	KA 2073	0008910044J	

DESCRIPTION	KAPOOR NR	O.E.M. NR.	
AIR CLEANER HOSE 1985 MODEL	KA 2074	252509136306	
PROPELLER SHAFT RUBBER 1985 MODEL	KA 2075	257341307504	
REAR ENGINE MOUNT 1210 SE	KA 2077	252324100106	
FRONT ENGINE MOUNT 1210 SE	KA 2078	252324100101	
AIR CLEANER HOSE 1210 SE	KA 2097	252509136306	

DESCRIPTION	KAPOOR NR	O.E.M. NR.	
SUPPORT MOUNT MASSEY FERGUSON TRACTOR	KA 2566		
BRAKE SEAL	KA-2628		



DESCRIPTION	KAPOOR NR	O.E.M. NR.		
EQUALIZER BUSH YORK	KA 2048		Q 51	
EQUALIZER BUSH YORK	KA 2049		Q 41.5	
RADIUS ARM BUSH YORK	KA 2050		Q 22	
CONTROL ARM BUSH R.O.R	KA 2051		Q 22	
CONTROL ARM BUSH R.O.R	KA 2052		Q 22	

Drawings, Pictures, References from car/truck makers or OE suppliers are given for identification of the parts and have only a guidance value.

DESCRIPTION	KAPOOR NR	O.E.M. NR.		
RADIUS ARM BUSH R.O.R	KA 2053		Q 32.5	
CAMBANA RUBBER PAD	KA 2232			
FIFTH WHEEL BUSH	KA 2269			
RADIUS ARM BUSH BIG FREHAUF BPW	KA-2706	000.1108858		
RADIUS ARM BUSH SMALL FREHAUF BPW	KA-2707	000.1108857		

DESCRIPTION	KAPOOR NR	O.E.M. NR.		
SPRING BUSH	KA-2721			
CONTROL ARM BUSH	KA-2877		Q 30	
EQUILIZER ARM BUSH BPW	KA-2945		Q 60	
TORQUE ARM BUSH BPW	KA-2946		Q 36	
TORQUE ARM BUSH BPW	KA-2952			

Drawings, Pictures, References from car/truck makers or OE suppliers are given for identification of the parts and have only a guidance value.

DESCRIPTION	KAPOOR NR	O.E.M. NR.		
SUSPENSION REPAIR KIT FREHAUF	KA-21002			
SILENT BLOC TRAILER 25.6 MM	KA-21004		Q 25.6	
SILENT BLOC TRAILER 52 MM	KA-21006		Q 52	
SILENT BLOC TRAILER 30 MM	KA-21009		Q 30	
CONTROL ARM BUSH 50 MM	KA-21065		Q 50	



DESCRIPTION	KAPOOR NR	O.E.M. NR.	
SILENT BLOC	KA-21066		 A black, cylindrical silent bloc component with a white top surface. A semi-transparent watermark with the text "KAPOOR'S" is overlaid on the image.

KA-21207

4 177 3010 00

Spring Suspension Bush

Also suitable for : BPW, Renault, SAF etc

30 x 68 x 104



KA-21205

02.0316.90.00

Spring Suspension Bush

Also suitable for : BPW, Renault, SAF etc

30 x 57 x 102



KA-21350

02.0315.98.00

Spring Suspension Bush

Also suitable for : BPW, Renault, SAF etc

30 x 60 x 72



KA-21322

SK 125900

Fifth Wheel Repair Kit

Also suitable for : Jost

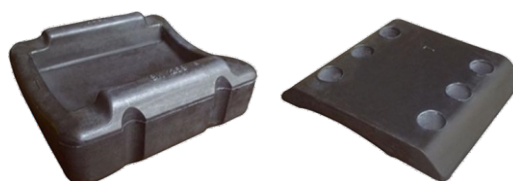

KA-21322 A

SK 2105.25

Fifth Wheel Repair FULL Kit

Also suitable for : Jost





KA-2134

0314014010
Spring Cushion for Leaf Spring (Small)

Also suitable for : BPW



KA-2134 A

0314016010
Spring Cushion for Leaf Spring (Big)

Also suitable for : BPW



KA-21331

Bearing Bush

Also suitable for : SAF



KA-21332

4 177 3028 00
Bearing Bush

Also suitable for : SAF



KA-3007

0 318 802020
C Clip

Also suitable for : BPW

KA-3008

0331038200
0331038210
Nylon Seal Ring 14 Ton



KA-3009

0331099010
0331099020
Nylon Seal Ring 16 Ton



KA-3020

03.084.46230
Brake Shoe Bolt

Also suitable for : BPW



KA-3021

0308442050
Spring Pin Brake Shoe



KA-3023

0316723020
Holding Metal Sheet

Also suitable for : BPW





KA-3024

095.565
Repair Kit Fifth V



KA-3033

03.370.25.16.0
Thrust Washer



KA-3034

03.320.65.05.0
Metal Washer for Axle

Also suitable for : BPW



KA-3035

ROE53363
Metal Bushing Josh Trailer



KA-21409

Foot Pin Bush

KA-21410

198601
FLAT RUBBER

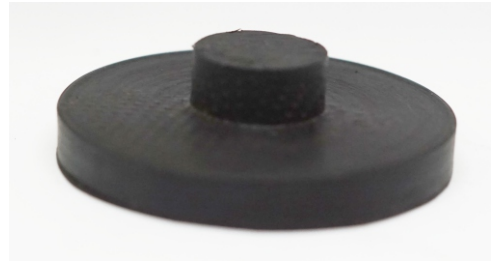

KA-21410A

198602
FLAT RUBBER

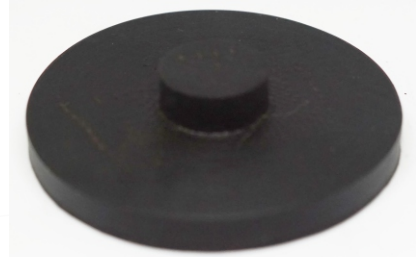

KA-21415

RUBBER BUSH



KA-21416

RUBBER BUSH



KA-21417

RUBBER BUSH





KA-21417

SILENT BLOC BUSH







KA-21432





ENGINE MOUNT
5006250987



Suitable for - IVECO

DESCRIPTION	KAPOOR NR	O.E.M. NR.	
EXHAUST PIPE SUPPORT	KA 2251	1206968-9	
STABLIZER BUSH	KA 2252	1288199	
STABLIZER LINK BUSH	KA 2254	1209991-1	
EXHAUST PIPE SUPPORT	KA 2255	666407-2	
SPRING BUFFER F10, F12, F16 FH12, FH16	KA-2719	1503490-3 1506 399	

DESCRIPTION	KAPOOR NR	O.E.M. NR.		
SPRING BUSH	KA-2720		Q30	
SPRING BUSH	KA-2721			
RADIATOR MOUNT VOLVO F 10, F 12	KA-2826	1660079		
RADIATOR MOUNT VOLVO F 10, F 12	KA-2827	1544239 476343		
ENGINE MOUNT VOLVO F 10	KA-2828	15034903		

DESCRIPTION	KAPOOR NR	O.E.M. NR.	
GEAR BOX MOUNT VOLVO F 10	KA-2829	3173759	
GEAR BOX MOUNT VOLVO F 12	KA-2830	1614600	
LEAF SPRING PAD VOLVO	KA-2831	1628397	
ENGINE MOUNT VOLVO F 12	KA-2832	1502144-7	
SPRING CUSHION LKW	KA-21094	1629553	

DESCRIPTION	KAPOOR NR	O.E.M. NR.		
CONTROL ARM MOUNT LKW	KA-21098	3173759 1075255	Q137	
TRANSMISSION MOUNT LKW	KA-21099	1614600		
ENGINE MOUNT	KA-21128	20723224		
ENGINE MOUNT	KA-21129	1629614 3198122		
AXLE ROD REPAIR KIT	KA-21130	274070	Q75X130	

DESCRIPTION	KAPOOR NR	O.E.M. NR.		
AXLE ROD REPAIR KIT	KA-21131	274019	Q85X130	
AXLE ROD REPAIR KIT	KA-21132	274056	Q85X152	



KA-21223

1134962
Shock absorber bush



KA-21129

70301773
Engine mount



KA-21128

20723224
Engine mount



KA-25009

20503552
Engine mount



KA-21298

20442252
Rubber to metal bearing

Also suitable for :

74 20 442 252

RENAULT

KA-21305

20390840
Suspension Mount



KA-2905

20471422
1068208
Propeller Shaft Support
Ø55MM



KA-21326

1079225
Stabilizer Mounting



KA-21327

1077594
Stabilizer Mounting



KA-21311

2053 3294
Leaf Spring Bush

20.5 x 52.5 x 110





KA-21325

324842
Round buffer

50 x 40 / M12 X 1.75



KA-2831

1591299
Rubber plate



KA-21293

21271207
Cabin Suspension Bush



KA-21287

20498623
Tightening Strap



KA-21131

274019
Repair kit for V- link
OD: Ø85mm; Hole: 21mm;
Length: 165mm; PCD: 130mm

Also suitable for :

81.43220.6203	MAN
0691 709	DAF
0 4253 5204	IVECO

KA-21195

275988

Repair kit for front axle link
 OD: Ø67mm; Hole: 15mm;
 Length: 129mm; PCD: 100mm

Also suitable for :

81.43220.6202	MAN
0 550 812	SCANIA



KA-21193

273612 / 20702095

Repair kit for V- link
 OD: Ø95mm; Hole: 21mm;
 PCD: 130mm

Also suitable for :

74 20 702 095	RENAULT
---------------	---------



KA-21130

274070

Repair kit for V- link
 OD: Ø75mm; Hole: 21mm;
 Length: 163mm; PCD: 130mm

Also suitable for :

1252 284	DAF
0 9316 1960	IVECO



KA-21132

274056 / 276192

Repair kit for V- link
 OD: Ø95mm; Hole: 23mm;
 Length: 190mm; PCD: 152mm

Also suitable for :

0696 321	DAF
1 104 336	SCANIA





KA-21191B

85104224

Repair kit for transverse link
 OD: Ø75mm; Hole: 17mm;
 Length: 143mm; PCD: 130mm

Also suitable for :

81.43220.6244	MAN
74 85 104 224	RENAULT
1 517 403	SCANIA



KA-21191A

20547286

Repair kit for V- link
 OD: Ø75mm; Hole: 19mm;
 Length: 145mm; PCD: 115mm

Also suitable for :

81.43220.6241	MAN
1 515 981	SCANIA
74 20547286	RENAULT



KA-21375

364833

Transmission Mounting